

ELGA

MEDICA Pro 30/60/120
Operator Manual

Copyright Note

The information contained in this document is the property of VWS (UK) Ltd. and is supplied without liability for errors or omissions.

No part of this document may be reproduced or used except as authorized by contract or other written permission from VWS Ltd. The copyright and all restrictions on reproduction and use apply to all media in which this information may be placed.

VWS Ltd. pursue a policy of continual product improvement and reserve the right to alter without notice the specification, design, price or conditions of supply of any product or service.

© VWS (UK) Ltd. 2007

All rights reserved.

Publication ref: MANU38364

Version 6 – 01/19

TABLE OF CONTENTS

1.	INTRODUCTION	3
1.1	Use of this Manual.....	3
1.2	Customer Support	3
1.3	HEALTH AND SAFETY NOTES	3
1.4	Electricity	3
1.5	Pressure	3
1.6	Sanitization Chemicals	4
1.7	Control of Substances Hazardous to Health (COSHH).....	4
1.8	Consumables.	4
2.	INSTALLATION AND COMMISSIONING	5
2.1	Installation	5
2.2	Commissioning.....	5
3.	CONTROLS	6
3.1	User Recognition Keys.....	7
3.2	System Preferences	7
3.3	Setting Consumable Replacement Reminders	15
4.	OPERATION	17
4.1	Night service/Operational day (screen 030).....	17
4.2	Continuous Recirculation (24/7) (screen 029)	17
5.	MAINTENANCE	18
5.1	Replacing Composite Vent Filter (L136)	18
5.2	Replacing Medpure L1 (LC174)	18
5.3	Replacing Ultra-Microfilter LC109	19
5.4	Replacing UV lamp LC105	20
5.5	Replacing Protek L1 (LC175) or Protek L2 (LC177) Pre-treatment Cartridges	21
5.6	Replacing E- Cartridge (LC181) standard on RE variant only.....	22
5.7	RO modules	22
6.	SANITIZATION	23
6.1	RO sanitization (Step 1)	23
6.2	Sanitization chemical safety data	25
7.	EMERGENCY BYPASS	26
7.1	Emergency bypass (MEDICA R/RE/RX).....	26
7.2	Emergency bypass (MEDICA B/S/SE).....	26
7.3	Calculation for Medpure L1 Cartridge life	27
8.	TROUBLE SHOOTING	28
9.	KEY TO CONTROL PANEL	29
10.	TECHNICAL SPECIFICATION	30
11.	WARRANTY/CONDITIONS OF SALE	32
12.	USEFUL CONTACT DETAILS	34

INTRODUCTION

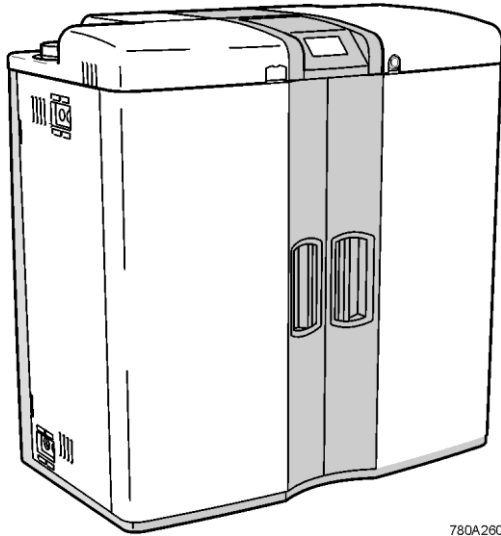

780A260

1.1 Use of this Manual

ELGA LabWater strive to produce manuals that are as simple and accurate as possible. However, should you feel they can be improved in any way please email us at info@elgalabwater.com

This manual guides you through the installation, commissioning and basic operation of the MEDICA Pro 30/60/120 allowing you to obtain a guaranteed supply of purified water to meet your requirements. For more detailed information refer to the Operator Manual supplied on CD.

1.2 Customer Support

Service support and consumable items are available from your local supplier or distributor. Please contact info@elgalabwater.com for further information.

1.3 HEALTH AND SAFETY NOTES



WARNING! WARNINGS ARE GIVEN WHERE FAILING TO OBSERVE THE INSTRUCTIONS COULD RESULT IN INJURY OR FATALITY.



CAUTION! Cautions are given where failure to observe the instructions could result in damage to the equipment, associated equipment and processes.

1.4 Electricity

It is essential that the electrical supply to the MEDICA Pro 30/60/120 is isolated before any items are changed or maintenance work performed.

The external isolator providing power to the unit should be positioned so that it is easily accessible.



WARNING! THIS APPLIANCE MUST BE EARTHED.

1.5 Pressure

The water supply should be isolated and residual pressure released prior to removal of any components or carrying out work on the unit.

Switch off the process and relieve pressure in the distribution loop by opening a point of use or dispense tap.

1.6 Sanitization Chemicals

During the automatic sanitization cycles, CT3 tablets are used and relevant safety information is included in this handbook. A safety data sheet conforming to COSHH regulations is also provided with the disinfectant and should be read before any tablets are used.

1.7 Control of Substances Hazardous to Health (COSHH)

Material safety data sheets covering the various replaceable components are available upon request. Contact your local ELGA LabWater distributor.

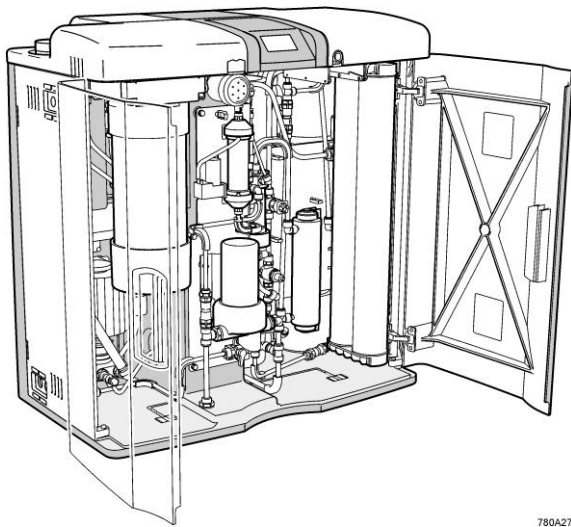

780A271

1.8 Consumables.

Consumables	Typical Service Life*	Max. Shelf Life
LC105 (UV lamp)	12 months	5 years
LC109 (UMF)	6 months	2 years
LC136 (Vent filter)	6 months	2 years
LC174 (Medpure L1 cartridge)	3-12 months	2 years
LC175 (Protek L1)*	6 months	2 years
LC 177 (Protek L2)*	12 months	2 years
LC180 (RO cartridge 60 L/hr)	3 years	2 years
LC181 (E-Cartridge)**	3 years	2 years
CT3 (Sanitization tablet)	Typical usage 2 to 6 tablets per month***	2 years

* Service Life is an estimate only, and will depend on the application and feed water quality. Care should be taken to order the correct consumable items.

** Optional - Consumables not fitted as standard. Fit only after consultation with ELGA Technical Support

*** Sanitization tablets are used typically 2 to 6 tablets per 1 to 6 months depending on bacteria monitoring, local feed water conditions and usage.

2. INSTALLATION AND COMMISSIONING

2.1 Installation

The unit is supplied with a quick start manual that allows the unit to be quickly installed and commissioned.

It is recommended that a trained ELGA representative carry out the installation of the product.

2.2 Commissioning

The unit is supplied with the software set in a commissioning mode that must be completed before being used to supply the application.

It is recommended that a trained ELGA representative complete the installation of the product.

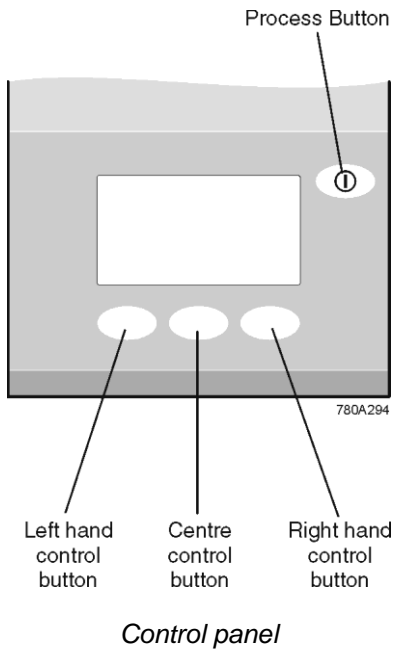

3. CONTROLS

The **MEDICA** control panel has a range of control icons. General icons are as follows. Further icons are described in the appropriate sections a complete listing is included in Section 11.

BUTTON	ICON	Function
PROCESS		Turns the unit on/off
LEFT		Menu
		Scroll
		Shift
		Up
CENTRE		Accept
		Replacement dates
RIGHT		Mute Alarm
		Down

3.1 User Recognition Keys

Your unit is supplied with the following User keys:

Master Key	(Black)	1off
User Key	(Blue)	4off
Sanitization Key	(Green)	2off

The Master Key should be stored in a safe place. The Master Key controls the access level of the other User Keys.

User Keys only have access to customer preference screens.

Sanitization Keys start the sanitization process and stop the general user from accidentally starting sanitization.

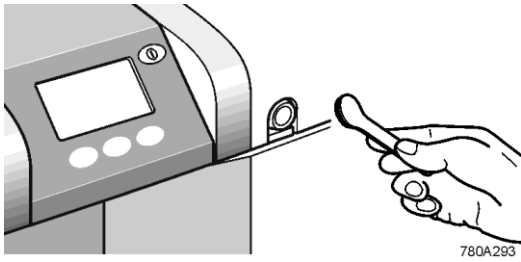

Present the Master or User Key



CAUTION! If the Master Key is lost a new Key can only be programmed by ELGA Service Engineers.

3.2 System Preferences



When the **MEDICA** unit is started for the first time after completing the commissioning routine the following steps should be carried out to set up your choices:

Note: Your choices can be changed and implemented during normal operation. It is not necessary to stop the unit.

Step 1 - System access (User Key)

The User Key prevents unauthorized access to specific settings. This ensures consistent system performance and operation.

Note: The User Key does not prevent access to the PROCESS function in case of emergency.

1. SWITCH on the main electrical supply to start the controller set-up sequence. This takes several seconds.
2. PRESENT the 'Master Key' (black) or the 'User key' (blue) to the reader ensuring clean contact of both metallic components.
3. The display will show a padlock .
4. REMOVE 'Key' from the reader.
5. The display will show a key .
6. PRESS  button.

Note: If no buttons are pressed the system will relock after 5 seconds

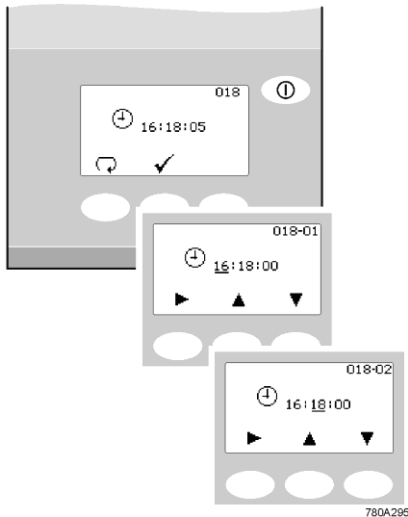

Setting clock time

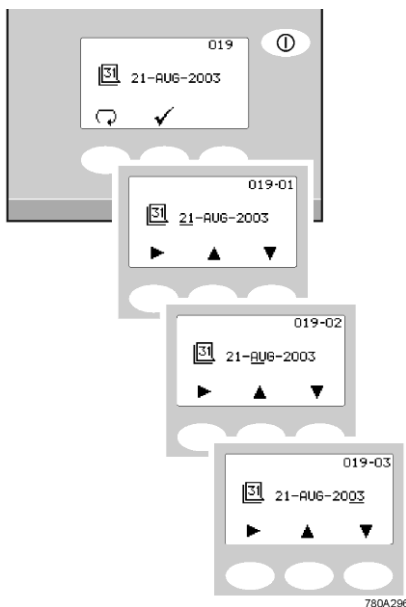



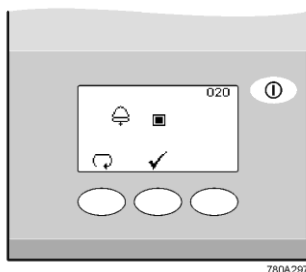





Set date screens













Audible alarm enable screen

Step 2 - Clock (screen 018)

1. PRESS  to edit time
OR
PRESS  to proceed to step 3.
2. PRESS and HOLD  to increase or  to decrease hour.
3. PRESS  to step cursor onto minute.
4. PRESS  to increase or  to decrease minutes.
5. PRESS .



Step 3 - Date (screen 019)

The date is used to initiate change reminders, the date will appear on printed records.

1. PRESS  to edit date
OR
PRESS  to proceed to step 4.
2. PRESS and HOLD  to increase or  to decrease day.
3. PRESS  to step cursor onto month.
4. PRESS  to increase or  to decrease month.
5. PRESS  to step cursor onto year.
6. PRESS  to increase or  to decrease year.
7. PRESS .

Step 4 - Audible alarm enabled/disabled (screen 020)

This screen provides the option of either turning on the audible alarm, causing it to sound (while the alarm icon flashes) or turning off the audible alarm meaning it will remain quiet

1. PRESS  to change mode (■ = ON)
OR
PRESS  to proceed to step 5.
2. PRESS .

Note: The visual alarm cannot be disabled.

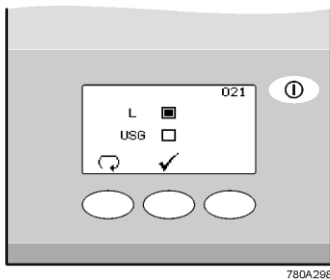

Set units of measure - volume

Step 5 –Set units of measure - Volume (screen 021)

This screen allows units of water volume to be set, to either **Litres** or **US Gallons**. This only indicates the volume in the reservoir.

1. PRESS to change (L or USG)
OR
PRESS to proceed to step 6.
2. PRESS .

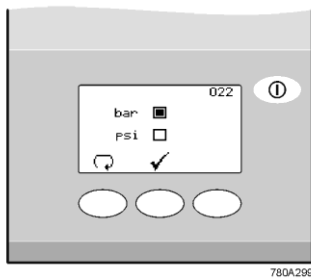

Set units of measure - pressure

Step 6 - Set UOM – Pressure (screen 022) R/RE variants only.

This screen allows preferred displayed units of water pressure to be set, to either, psi or Bar. This only indicates the pressure as measurement in the recirculation loop.

1. PRESS SCROLL to change mode (psi or bar)
OR
PRESS TICK to proceed to step 7.
2. PRESS TICK .

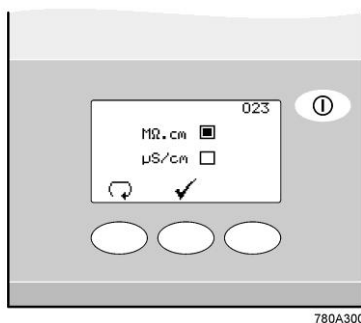

Water purity unit setting

Step 7 - Water purity unit setting (screen 023)

This screen allows preferred displayed units of water purity to be set, to either, **MΩ.cm** or **µS/cm**. This only affects the quality measurement in the recirculation loop.

1. PRESS SCROLL to change mode (MΩ.cm or µS/cm)
OR
PRESS to proceed to step 8.
2. PRESS .

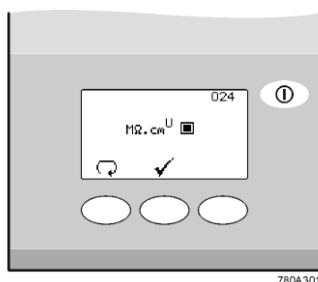

Uncompensated water quality screen

Step 8 - Uncompensated water quality (screen 024)

A U will indicate uncompensated readings (recirculation loop only) in the normal process screen.

1. PRESS to change (■ = Uncompensated water quality ON)
OR
PRESS to proceed to step 9.
2. PRESS .

Note: This mode is for validation purposes only and should not be selected as standard.

Step 9 - RO water quality alarm settings QS1 (screen 025)

This screen is used to set the value at which the RO water quality alarm will sound. This alarm does not stop RO production but can extend or start flush routines.

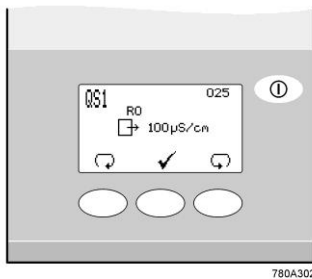

Alarm settings QS1 screen

1. PRESS to select alarm point (Increments of 10, ranging from 20 to 100µS/cm). If '0' is selected the alarm will be turned 'OFF'.
OR
PRESS to proceed to step 10.
2. PRESS .

Step 10 - Product water purity alarm settings QS2 (screen 026)

This screen is used to select the value at which the product water purity alarm will activate. The alarm does not stop the unit and will automatically reset if the purity level recovers

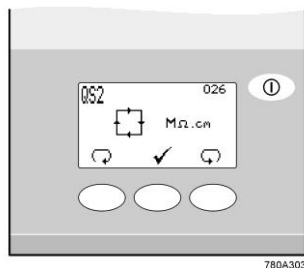

Alarm settings QS2 screen

1. PRESS to select alarm point (increments of 1, ranging from 1 to 10 MΩ.cm).
OR
PRESS to proceed to step 11.
2. PRESS .

Step 11 - RO water temperature alarm settings TS1 (screen 027)

This screen is used to select the value at which the RO water temperature alarm will activate. The alarm does not stop the unit and will automatically reset if the temperature returns below the set point.

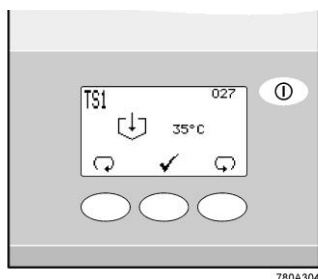

Alarm settings TS1 screen

1. PRESS to select alarm point (increments of 1, ranging from 20 to 50°C)
OR
PRESS to proceed to step 12.
2. PRESS .

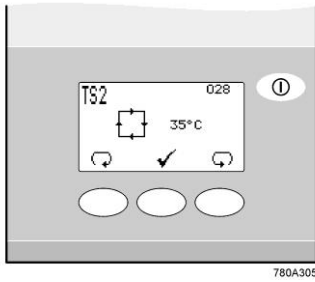

Alarm settings TS2 screen

Step 12 - Product water temperature alarm settings TS2 (screen 028)

This screen is used to select the value at which the product water temperature alarm will activate. The alarm does not stop the unit and will automatically reset if the temperature returns below the set point.

1. PRESS to select alarm point (increments of 1, ranging from 20 to 50°C)
OR
 PRESS to proceed to step 13.
2. PRESS .

Note: If the water temperature rises above 55°C in the system it will alarm, stop and await operator intervention - alarm will be reset once power is removed for 5 seconds and then reinstated

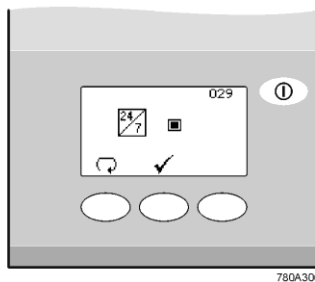

Continuous operation screen

Step 13 - Continuous operation (screen 029)

Continuous operation may be required in particular circumstances or when demand for water fluctuates.



CAUTION! During long periods of continuous operation and low usage the water temperature will rise. It is recommended that this function is only used when water usage is on average >50 litres/hr and water is used every day.

1. PRESS to change (■ = ON)
OR
 PRESS to proceed to step 14.

Note: Proceed to step 16 if continuous operation is selected (■ = ON).

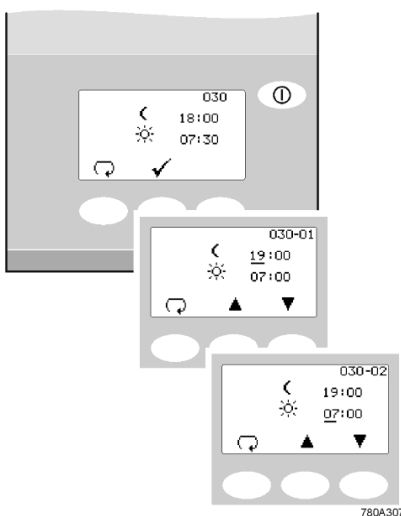



Setting period of operation

Step 14 - Periods of operation (screen 030)

For efficiency and to reduce the likelihood of heat build up the normal operational hours can be selected.

During 'OFF' periods the unit will automatically re-circulate water for a period of 10 minutes every two hours this will maintain water purity within the distribution loop.

1. PRESS to edit night service start
OR
 PRESS to proceed to step 15.
2. PRESS to increase or to decrease time in increments of 30 minutes.
3. PRESS to step to night service end.
4. PRESS to increase or to decrease time in increments of 30 minutes.

5. PRESS  to enter times.
6. PRESS .

Note: Night service will only be operational if Continuous Operation is not enabled.

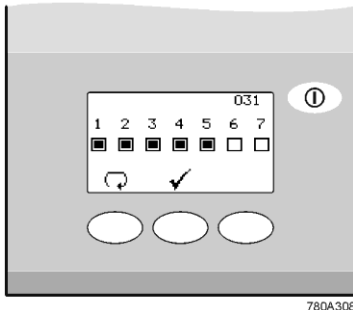





Day selection screen



Step 15 - Operational days selection (screen 031)

Select the days that the **MEDICA** is required to operate by highlighting the relevant box.

Monday = 1, Sunday = 7

1. PRESS  to enter selection screen
 OR
 PRESS  to proceed to step 14.
2. PRESS  to highlight box 1 (■ = Monday enabled)
 OR
 PRESS  to step to box (2).

Note: A highlighted box indicates that the unit will be operational on that day between the times set in step 14.

3. REPEAT, step 15 - item 2, to select further operating days or PRESS  until the  appears.
4. PRESS .



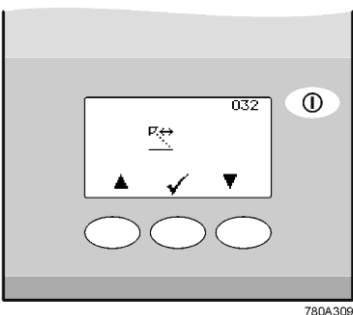

Note: During the selected off periods the unit can be restarted by pressing PROCESS. A few minutes operation should be allowed before use to allow water purity to reach a high.



Viewing angle adjustment screen

Step 16 - Display viewing angle adjustment (screen 032)

The angle of the display can be adjusted up and down for better viewing of the screen.

1. PRESS and HOLD  or  to adjust the viewing angle
 OR
 PRESS  to proceed to step 17.
2. PRESS .

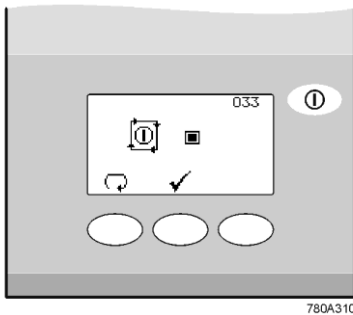

Auto-restart screen

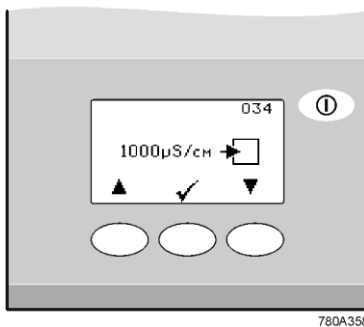

Feed Water Quality Screen

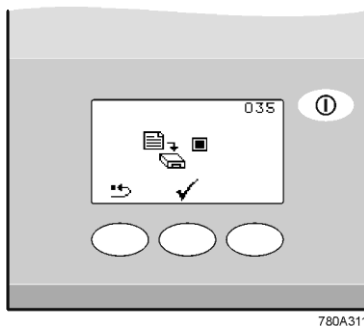

Data output screen

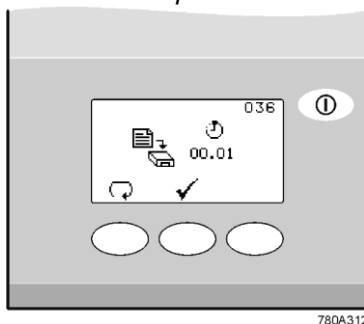

Data transmit screen

Step 17 - Auto-restart (screen 033)

This allows selection of the AUTO restart option. If auto restart is selected the unit will automatically restart after a power failure. In manual mode the unit will stay in standby after a power failure.

1. PRESS to change mode (■ = ON)
OR
PRESS to proceed to step 18.
2. PRESS .

Step 18 - Feed Water Quality (screen 034)

An indication of the RO performance can be obtained using a calculation of ionic rejection in which the conductivity of the permeate is compared to that of the feedwater.

Enter the feedwater conductivity to obtain an accurate measurement.

1. PRESS to reduce the value to the correct reading
2. PRESS to accept

Step 19 - Data output (screen 035)

The **MEDICA** can transmit operational data to an Xport storage device.

1. PRESS to change (■ = ON)
OR
PRESS to proceed to step 20.
2. PRESS .

Step 20 - Data transmit (screen 036)

Setting the frequency of data transmittals to Xport.

1. PRESS to change transmit intervals (1, 5, 15, 30min / 1,6 hour)
OR
PRESS to proceed to step 21.
2. PRESS .

Note: PRESS PRINT during normal operation and current data will be transmitted if data output (035) is selected.

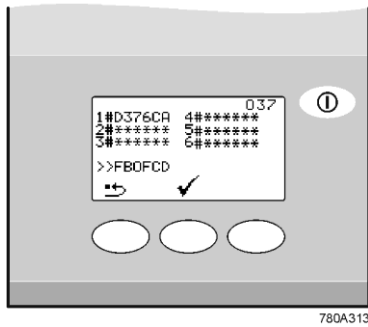

Programming of user keys screen

Step 21 - Programming of User Keys (screen 037)

During the life of the **MEDICA** you may need to delete or add User keys to prevent or allow access to user choices. This feature is only available to the Master key holder.



CAUTION! Do not press reset unless all User Keys are present.

1. PRESS ↵ to delete all User keys
2. PRESENT the new User key to the reader.
3. PRESS →** to load new User key identification.
4. REPEAT instruction 2 and 3 until all User keys are registered (maximum of 6 users).
5. PRESS ✓ to complete settings.

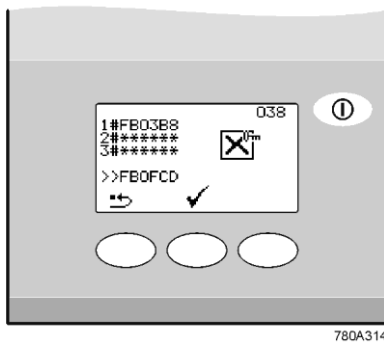

Programming of Sanitization Keys screen

Step 22 - Programming of Sanitization Keys (screen 038)

Sanitization Keys are required to start a Sanitization. These keys can be deleted or added.

1. PRESENT Master key to the reader
2. PRESS ✓ until the Sanitization Key programming screen appears.
3. PRESS ↵ to delete all Sanitization keys
4. PRESENT the new Sanitization Key to the reader.
5. PRESS →** to load new Sanitization key identification.
6. REPEAT instruction 4 and 5 until all Sanitization keys are registered (maximum of 2 users).
7. PRESS ✓ to complete settings.

3.3 Setting Consumable Replacement Reminders

Step 1 - Enter consumable replacement timer set-up



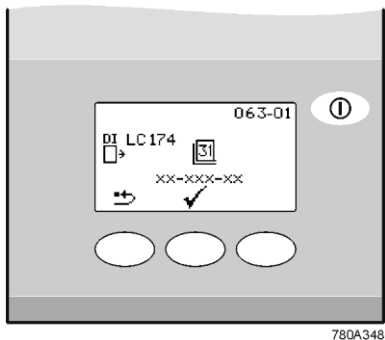

1. TURN unit off at electrical supply.
Note: Allow time for the display to go blank after the power is removed.
2. SWITCH electrical supply on.
3. PRESENT Master Key and PRESS  button to enter the Consumable Timer set up.



780A348

Medpure L1 replacement date screen

Step 2 – Medpure L1 replacement date



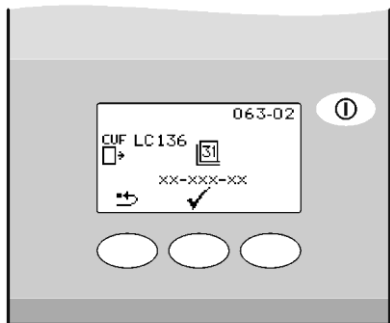

1. PRESS  button to reset cartridge replacement date
OR
PRESS  to accept replacement date and proceed to CVF Reminder.
2. PRESS  to confirm that resetting is required
OR
PRESS  to abort reset.
3. PRESS .



780A339

CVF replacement date screen

Step 3 – Composite Vent filter (CVF) replacement date



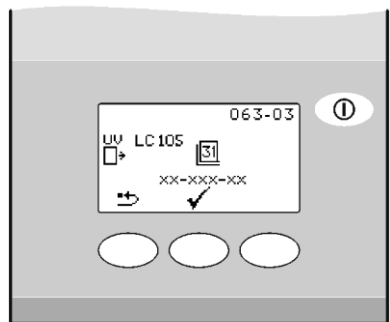

1. PRESS  button to reset CVF replacement date
OR
PRESS  to accept date and proceed to UV lamp Reminder.
2. PRESS  to confirm that resetting is required
OR
PRESS  to abort reset.
3. PRESS .



780A340

UV replacement date screen

Step 4 - UV lamp replacement date

1. PRESS  button to reset UV lamp replacement date
OR
PRESS  to accept replacement date and proceed to Protek Filter Replacement.
2. PRESS  confirm that resetting is required
OR
PRESS  to abort reset.
3. PRESS .

Step 5 - Protek L1/L2 replacement date

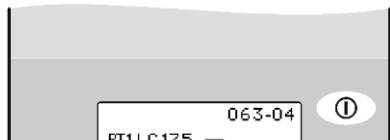

1. PRESS ↵ button to reset Protek L1/L2 replacement date
 OR
 PRESS ✓ to accept replacement date and proceed to UMF replacement.
2. PRESS ✓ confirm that resetting is required
 OR
 PRESS ✗ to abort reset.
3. PRESS ✓.

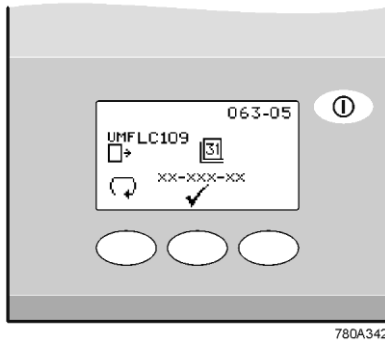

780A342

UMF replacement date screen

Step 6 – UMF replacement date

1. PRESS ↵ button to reset UMF replacement date
 OR
 PRESS ✓ to accept replacement date and proceed to Sanitization reminder.
2. PRESS ✓ confirm that resetting is required
 OR
 PRESS ✗ to abort reset.
3. PRESS ✓.

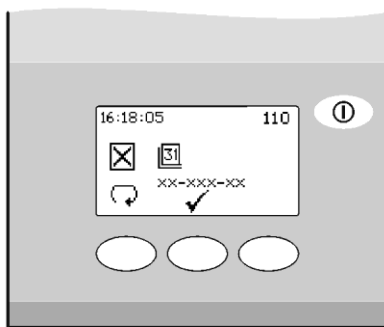

780A343

Sanitization reminder screen

Step 7 - Sanitization reminder

1. PRESS ↵ button to reset Sanitization replacement date
 OR
 PRESS ✓ to accept replacement date and complete settings.
2. PRESS ✓ confirm that resetting is required
 OR
 PRESS ✗ to abort reset.
3. PRESS ✓.

4. OPERATION

4.1 Night service/Operational day (screen 030)

Refer to Section 3.2 - Step 14 and 15.

Your **MEDICA** can be programmed to operate on specific days between selected times. This is to optimize the efficiency of the unit and to minimize rises in water temperature.

During the 'sleep' period the unit will display .

It is possible to override this mode by PRESSING .

During the 'sleep' period the unit will run in intermittent recirculation (10 minutes every two hours) to maintain water purity around the distribution loop.

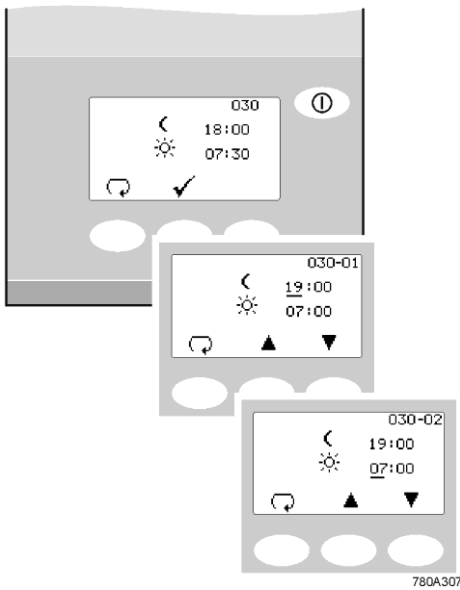

Night service/Operational day screen

4.2 Continuous Recirculation (24/7) (screen 029)

Refer to Section 3.2 - Step 13.

If the unit is set to continuous recirculation, it will constantly recirculate the water and fill the reservoir as required.

It is recommended that the system only runs in continuous mode when the demand for water is high (greater than 50% of the make up flow)

During recirculation the water temperature will tend to increase slowly.

5. MAINTENANCE

An approved supplier or distributor should carry out any maintenance work not included in this handbook.

Note: Disposal of all end of life consumable items should be in accordance with local statutory regulations



WARNING! ALWAYS CHECK THAT THE MAINS ELECTRICAL POWER AND FEED WATER ARE SWITCHED OFF BEFORE ATTEMPTING ANY MAINTENANCE PROCEDURE.

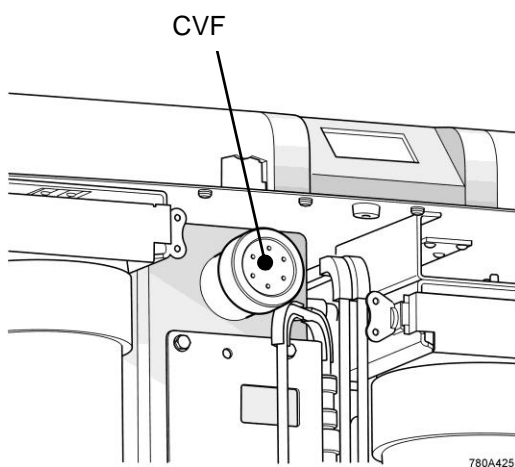

CVF position

5.1 Replacing Composite Vent Filter (L136)

The Composite Vent Filter (CVF) should be replaced in the following circumstances:

- When indicated by the alarm (screen prompt) or after a maximum of six months.
1. ENSURE process is OFF and isolate power.
 2. OPEN front doors and locate CVF.
 3. UNSCREW old CVF and discard
 4. UNPACK new CVF.
 5. WRITE the installation date on the label of the filter for future reference.
 6. INSTALL filter.
 7. SWITCH on power.
 8. RESET consumable reminder as described in Section 3.3.

5.2 Replacing Medpure L1 (LC174)

- When the purity of water from the unit starts to deteriorate.

When indicated by the consumable alarm or after a maximum of six months.

1. ENSURE process is OFF and isolate power.
2. OPEN right hand door and LOCATE Medpure cartridge.
3. PUSH Medpure FORWARD, then LIFT, finally PULL to remove the used cartridge. Discard.
4. UNPACK new Medpure.
5. REMOVE sealing plugs from inlet and outlet ports.
6. Wet 'O' rings and SLIDE new cartridge into position pushing upwards against pack reader contacts.
7. EASE back and ENSURE that the pack is fully engaged (down) in the retainers.
8. SWITCH on power. FOLLOW screen prompts to

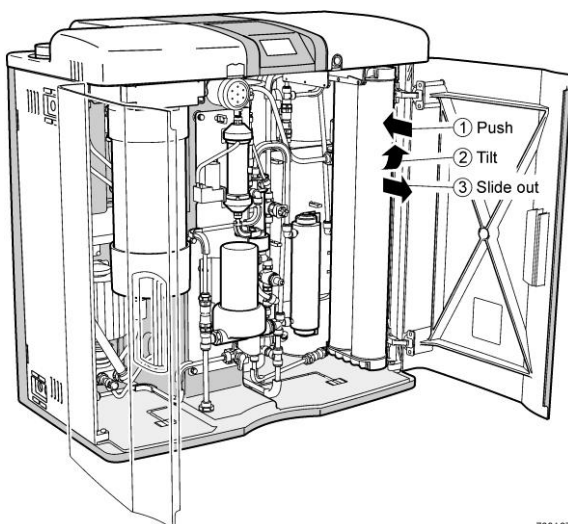

accept new cartridge replacement date

9. START unit and allow to circulate until water quality is achieved.

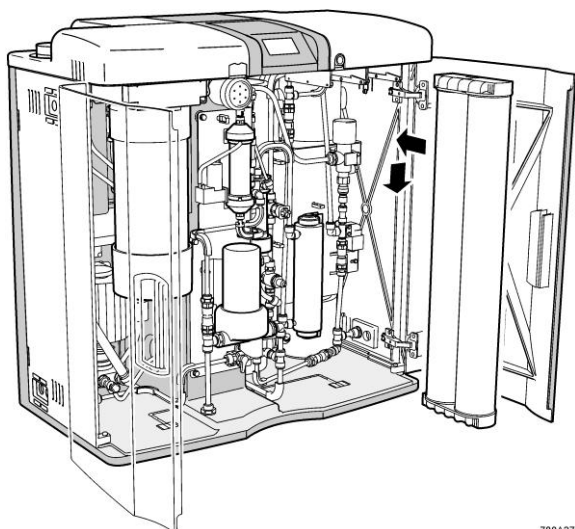

CAUTION! If operating the unit with two Medpure L1 purification packs installed, both packs must be replaced at the same time. Failure to do so will result in low water purity.

5.3 Replacing Ultra-Microfilter (LC109)

The Ultra-Microfilter (UMF) should be replaced in the following circumstances:

- Fill the reservoir to 48.5 liters (Max. Fill),
- Power down system,
- Remove package from LC109 and discard preservative to drain,
- Remove LC109 from MEDCIA Pro system,
- Install new LC109,
- Close valve#2 (Located on top side of LC109 – 6mm shutoff valve connecting to reservoir),

Note: If you received a high loop pressure alarm, you will then need to direct valve #2 (Marked as bypass procedure) – 6 mm tubing from the LC109 to drain as well.

- Direct the loop feed out to drain by using a 10mm tube or disconnect the loop return and direct to drain. (Make sure that the loop return is not connected to the MEDICA Pro – the preservative will effect the purification packs).

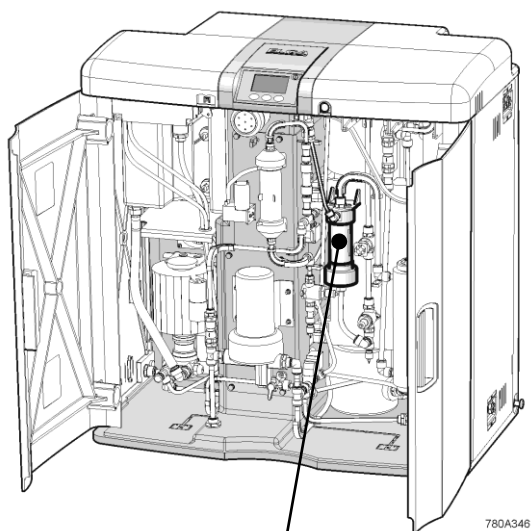

Ultra-Microfilter

Ultra-Microfilter position

5.4 Replacing UV lamp (LC105)

The UV lamp should be replaced in the following circumstances:

- When indicated by the consumable alarm.
 - After a maximum of twelve months use.
1. ENSURE process is OFF and ISOLATE power.
 2. OPEN the front doors.
 3. REMOVE Medpure pack to improve access to the UV lamp assembly
 4. LOCATE UV assembly on right-hand side of unit.
 5. REMOVE retaining spring clips from top and bottom of the lamp assembly
 6. REMOVE electrical connectors from top and bottom and take lamp from housing.

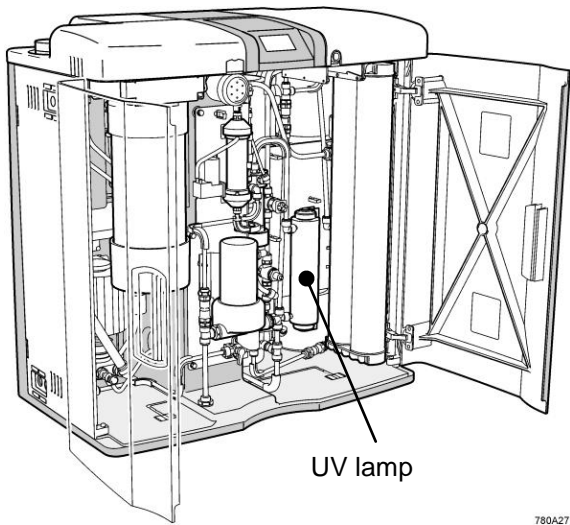

UV lamp

780A271

UV lamp position



WARNING! IT IS STRONGLY RECOMMENDED THAT DURING THE HANDLING OF THE LAMP CUT-RESISTANT GLOVES BE WORN.

7. DISCARD lamp.



Caution! Dispose of lamp in accordance with local authority regulations.

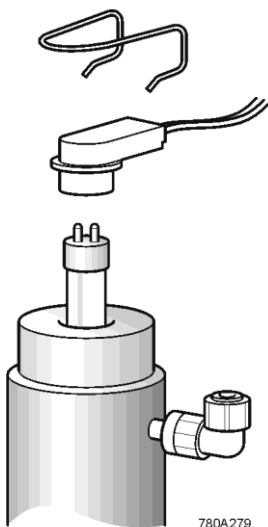

780A279

UV Lamp connection

8. REMOVE new lamp from packaging and follow instructions included for cleaning.
9. REFIT into UV assembly.
10. RECONNECT to electrical connectors top and bottom.
11. REFIT retaining spring clips top and bottom
12. REPLACE Medpure pack (if fitted).
13. RESET consumable reminder as described in Section 3.3.

Protek L1/L2

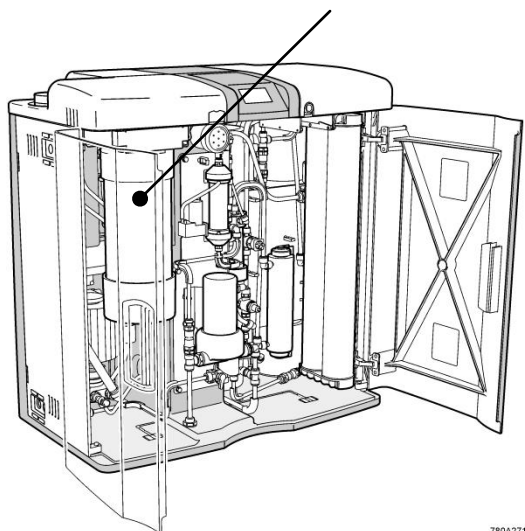

780A271

5.5 Replacing Protek L1 (LC175) or Protek L2 (LC177) Pre-treatment Cartridges

The replacement frequency of the pre-treatment cartridge is dictated by the purity of the feed water. It should be replaced in the following circumstances:

- When indicated by the consumable alarm
- When indicated by the alarm 75
- After replacement of RO modules
 1. ENSURE process is OFF and ISOLATE power.
 2. OPEN front doors
 3. LOCATE Protek
 4. Remove lid from break tank and RELEASE any residual system pressure by OPERATING float valve.
 5. TWIST to RELEASE clip and OPEN retaining clamp at top of cartridge
 6. PULL Protek forward
 7. DISCARD used cartridge in accordance with local regulations
 8. REMOVE new cartridge from packaging.
 9. REMOVE sealing plugs from inlet and outlet ports.
 10. Wet 'O' rings and SLIDE Protek until it is fully engaged
 11. CLOSE retaining clamp and fasten CLIP
 12. The unit will automatically recognize the new cartridge and date.

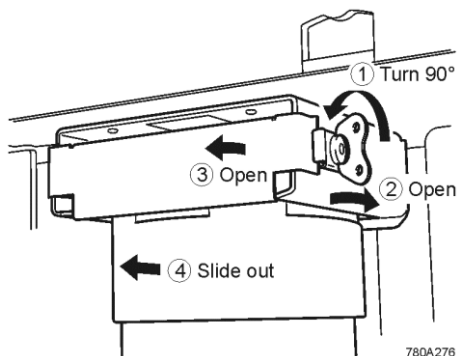

780A276

Protek L1/L2 removal

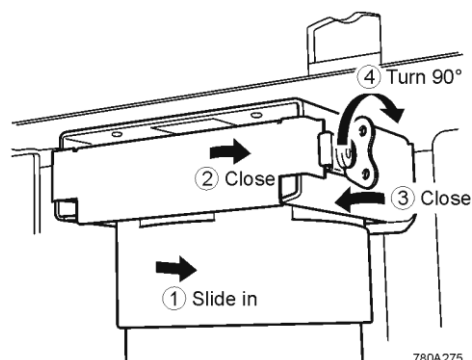

780A275

Protek L1/L2 replacement

5.6 Replacing E- Cartridge (LC181) *standard on RE variant only*

The E- cartridge should be replaced:

- When indicated by the alarm
1. ENSURE process is OFF and ISOLATE power.
 2. OPEN front doors
 3. LOCATE E – cartridge
 4. DISCONNECT tubing to air pump and inlet and outlet tubing from the E cartridge.
 5. REMOVE used cartridge from clip and discard in accordance with local regulations.
 6. TAKE new cartridge
 7. REMOVE sealing plugs from inlet and outlet ports
 8. LOCATE new cartridge in clip
 9. RE-CONNECT tubing

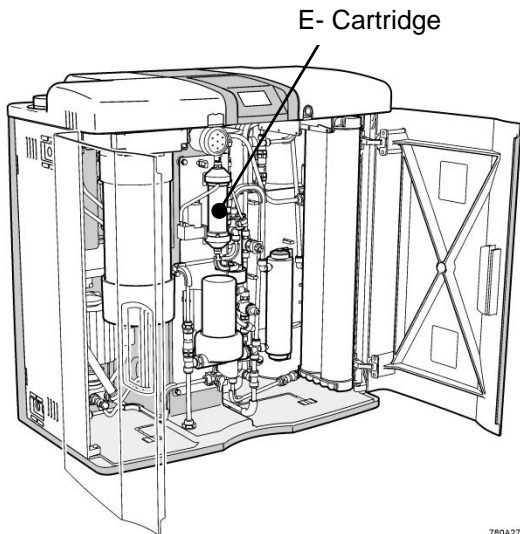

E-Cartridge position

5.7 RO modules

The reverse osmosis modules should be replaced if permeate water purity or flow rate is not adequate and does not meet predicted or previous performance. For information regarding the replacement of the reverse osmosis module contact Customer Services.

6. SANITIZATION

6.1 RO sanitization (Step 1)

Sanitization of the finished installation is essential to ensure that the system is properly commissioned and capable of achieving the bacteriological control required for a typical application.

1. PRESENT GREEN sanitization key to reader.
2. PRESS ✓ to enter sanitization.

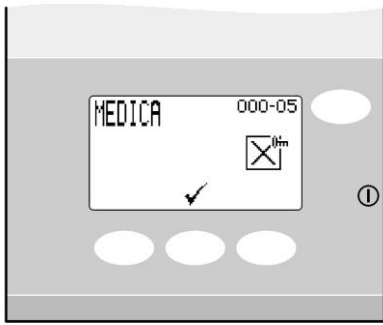

780A449

Sanitization selection screen

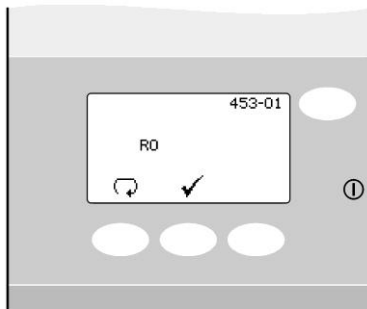

780A430

Enter RO sanitization

3. PRESS ✓ to enter RO sanitization.

4. UNSCREW the large white lid on the left of the unit.
5. ADD 2 CT3 tablets.
6. REPLACE lid.

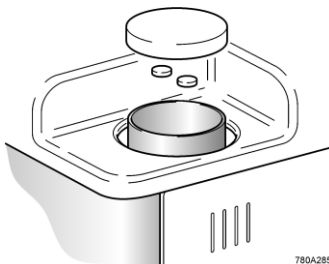

780A285

Large white cap removal

- PRESENT GREEN sanitization to reader to confirm that CT3 has been added.

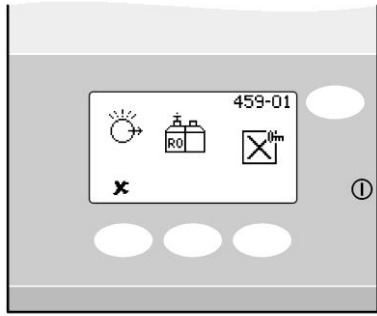

780A433

Confirmation CT3 is added

- The system now enters a period of automatic sanitization lasting approximately 45 minutes

Once the step within the sanitization is complete the unit will go straight into process and continue to fill the recirculation reservoir

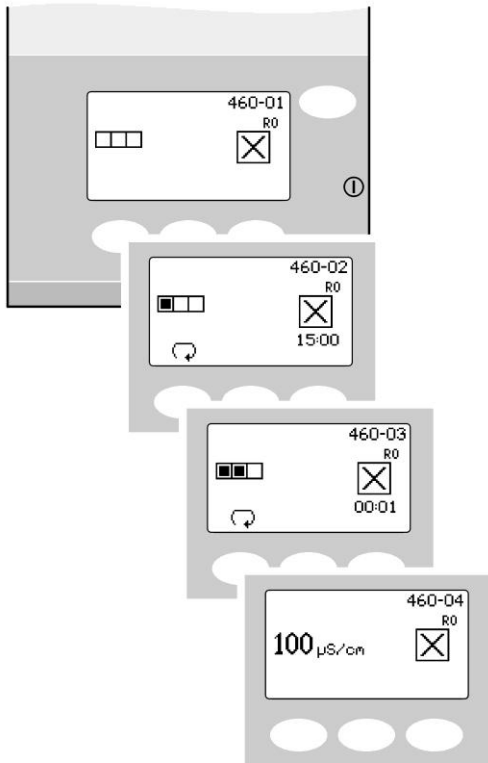

780A434

RO sanitization process steps

- PRESS ✓ to accept the sanitization reminder

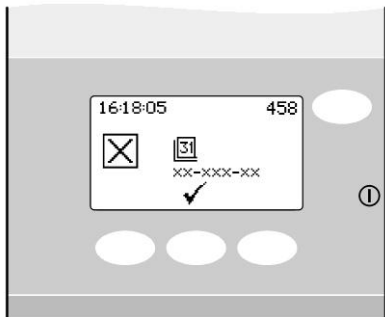

780A440

Set Sanitization reminder

6.2 Sanitization chemical safety data



WARNING! ENSURE THAT YOU AND OTHER STAFF WORKING ON THIS PRODUCT ARE FAMILIAR WITH THE POTENTIAL DANGERS AND THAT THE PROPER SAFETY EQUIPMENT IS AVAILABLE. IF IN DOUBT CONTACT YOUR LOCAL ELGA LABWATER REPRESENTATIVE.



CT3 SANITIZATION TABLET - SAFETY INFORMATION

General Description:		White solid tablet, which rapidly dissolves in water, used for sanitization applications
Hazard Assessment:		Contains sodium dichloroisocyanurate dehydrate, and is therefore toxic by inhalation, ingestion and skin contact.
Properties:		Soluble in water. pH 6. Non-combustible.
Handling Precautions:		Keep container tightly closed in dry place. Wear protective clothing when handling.
Spillage:		If tablets are dry and uncontaminated collect up and place in heavy duty plastic bag. Do not return to original container. Wash away any residues with copious amounts of water..
Toxicity:		Serious risk of poisoning by inhalation or ingestion. Irritating to skin, eyes and respiratory system.
First Aid	Eyes:	Thoroughly wash out with clean water for at least 15 minutes. OBTAIN MEDICAL ATTENTION.
	Inhalation:	Remove from exposure, rest and expose to fresh air. In severe cases, obtain medical attention and treat for acute chlorine poisoning.
	Skin:	Drench the skin with plenty of water. Remove contaminated clothing and wash before re-use. In severe cases, obtain MEDICAL ADVICE.
	Mouth:	Wash out the mouth thoroughly with water and give large quantities of milk to drink. Obtain MEDICAL ADVICE.
<i>Note: A comprehensive Data Sheet is available on request and is supplied with each packet of tablets</i>		

7. EMERGENCY BYPASS

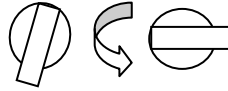

Contact your local service provider before putting the unit into emergency bypass.

7.1 Emergency bypass (MEDICA R/RE/RX)

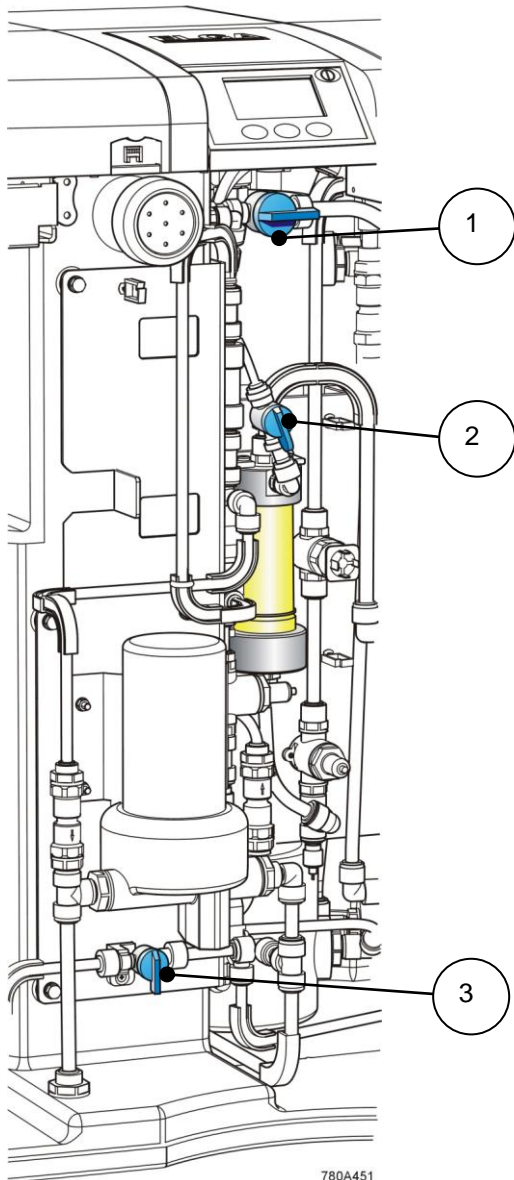
1. Ensure the process is OFF
2. Disconnect the electrical supply
3. Open the doors.
4. Close valve 1 
5. Close valve 2 
6. Remove yellow plastic cover 3
7. Open valve 3 
8. Close valve 3 when there is no requirement for purified water.
9. Monitor water purity independently or install new Medpure L1 cartridges to guarantee water purity.

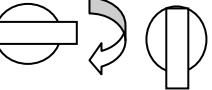

7.2 Emergency bypass (MEDICA B/S/SE)

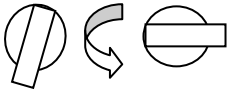
1. Ensure the process is OFF
2. Disconnect the electrical supply
3. Open the doors.
4. Close valve 1 
5. Valve 2 should remain closed 
6. Remove yellow plastic cover 3
7. Open valve 3 
8. Monitor the level in the reservoir to ensure it does not overflow.
9. Monitor water purity independently or install new Medpure L1 cartridges to guarantee water purity.

7.3 Calculation for Medpure L1 Cartridge life

Calculate the maximum Medpure cartridge life under emergency bypass processing and with your mains water conditions to maintain a supply purity of 1MΩ.cm to the analyzer

The maximum life expectancy of the Medpure L1 cartridge in emergency bypass mode while maintaining a supply purity of 1MΩ at the analyzer, may be calculated as follows:

Single Pack

$$\text{Time between pack changes} = \frac{120,000}{\text{Conductivity of mains water} \times \text{Water consumption of analyzer (l/hr)}}$$

Example

Mains water conductivity = 605 μS/cm

Water consumption of analyzer = 20 l/hr

$$\text{Time between pack changes} = \frac{120,000}{605 \times 20}$$

Time between pack changes =9.9 hr

In the absence of information on mains water conductivity, assume a pack life of 2 hr if the analyzer consumes 20 l/hr. If flows start to decline this may be improved by changing the UMF.

The capacity will be somewhat less (typically 20 to 40% less) if a water purity of 10 MΩ.cm is needed.

8. TROUBLE SHOOTING

If a problem occurs the unit will normally sound an alarm and the respective icon will flash. The audible alarm can be silenced by pressing the mute button.

The appropriate action to then take (for the more common alarm displays) is shown on the Quick Reference Guide (fitted to the inside of the door of the **MEDICA**.) If the unit cannot be repaired using the information shown, please call your local ELGA LabWater representative (See Section 12.0 - Useful Contact Details).







































WARNING! ALWAYS ENSURE THAT THE MAINS POWER SUPPLY IS ISOLATED BEFORE WORKING INSIDE THE UNIT.

Alarm Summary

Display id	icon	Alarm	Recommended Action
672-98		Leak Detection	<ul style="list-style-type: none"> PRESS mute to silence alarm REMOVE power rectify leak and dry sensors Dry the contacts POWER on to reset.
672-97		Reservoir level controls	<ul style="list-style-type: none"> PRESS mute to silence alarm REMOVE power Contact Technical Support
672-96		High loop pressure	<ul style="list-style-type: none"> PRESS mute to silence alarm REMOVE power Contact Technical Support
672-95		Permeate over temperature	<ul style="list-style-type: none"> PRESS mute to silence alarm Potable feed temperature is unacceptably high >50°C Contact Technical support
672-94		Recirc. loop over temperature	<ul style="list-style-type: none"> PRESS mute to silence alarm Water temperature is unacceptably high >50°C Contact Technical support
-93	LC175/LC177	Protek L1 incorrectly installed	<ul style="list-style-type: none"> PRESS mute to silence alarm CONFIRM Protek is correctly installed POWER OFF/ ON to reset
-92	LC174	Medpure L1 incorrectly installed	<ul style="list-style-type: none"> PRESS mute to silence alarm CONFIRM Medpure L1 is correctly installed POWER OFF/ ON to reset
-90	1MΩ.cm	Water purity alarm	<ul style="list-style-type: none"> PRESS mute to silence alarm CONFIRM purity displayed is suitable for application. CHANGE Medpure L1 if water purity is insufficient
-89	35°C	Water temperature alarm	<ul style="list-style-type: none"> PRESS mute to silence alarm CONFIRM temperature is suitable for application. ADJUST alarm setpoint or DIRECT water to drain to Introduce cool water
-88	100µS/cm	Permeate purity alarm	<ul style="list-style-type: none"> PRESS mute to silence alarm CONFIRM purity displayed is suitable for application. ADJUST alarm setpoint or contact local service provider.
-87	35°C	Permeate temperature alarm	<ul style="list-style-type: none"> PRESS mute to silence alarm CONFIRM temperature is suitable for application. ADJUST alarm setpoint or confirm potable supply temperature is suitable
-86		Break tank low	<ul style="list-style-type: none"> PRESS mute to silence alarm. CONFIRM pressure and flow of potable supply If problem persists contact local service provider
-85		UV lamp fail	<ul style="list-style-type: none"> PRESS mute to silence alarm CHANGE lamp at the next opportunity

9. KEY TO CONTROL PANEL

ICON	DESCRIPTION	ICON	DESCRIPTION
	Accept		User Recognition Key
	Auto restart		Locked
	Scroll back		Menu
	Step back		Mute alarm
	Bell		Night
	Standby		Option OFF
	Calibration point		Option ON
	Cancel		Output
	Clock		Recirculate
	Date		Reset
	Day		Right
	Down		Sanitization PASSkey
	Drain		Sanitization reminder
	Save data		Scroll
	Hazard		Transport mode
	Feed		UP
	Fill		Viewing angle
	Add chemical		Recirc

10. TECHNICAL SPECIFICATION

Feedwater			
Source	Potable tap water as detailed below. <i>Failure to comply with the minimum feedwater pretreatment recommendations will affect the life and performance of key components within the MEDICA, and may invalidate the warranty.</i>		
Contaminant	Measure	Range	Pretreatment
Calcium	Ca ppm as CaCO ₃	< 250 > 250	None Softener or use very low RO recovery
Total chlorine	Cl ppm	< 0.1 0.1 to 0.5 > 0.5	Protek L1 Protek L1 Protek L2
Silica	SiO ₂ ppm	< 30 > 30	Protek L1 or L 2 20 inch cartridge depth filter*
Fouling Index	FI	<20 > 20	Protek L1 or L2 Backwashable media filter with a minimum flow rate of 20l/min
Iron/manganese	Fe/Mn ppm	< 0.1 > 0.1	Protek L1 or L2 Back-washable pre- filter *
Organics	TOC ppm C	<3 > 3	Protek L1 or L2 Cylinder of carbon sized correctly
TEMPERATURE	4 - 40°C (Recommended 15 - 25°C)		
FLOWRATE (maximum requirement @15°C)	9l/min		
Drain requirements (gravity fall with air gap).	9l/min		
Feedwater Pressure	6 bar (90 psi) maximum, 2 bar (30 psi) minimum.		

* Installed in feed water supply.

Note: If feedwater purity is variable or values are close to the top of one of the ranges, provide pre-treatment for the higher range or seek advice from Technical Support at ELGA LabWater.

Dimensions				
Height	820 mm (32.8")		834 mm (33.4") including castors	
Width	794 mm (31.8")			
Depth	470 mm (18.8")			
	B	S	R	RE
Supply weight	44 kg	45 kg	52 kg	53 kg
Operational weight	101 kg	102 kg	109 kg	110 kg
Installation	Floor/ bench			

Connections	
Inlet	10 mm OD tube
Drain	10 mm OD tube
Reservoir drain	10 mm OD tube
Recirculation loop outlet*	10 mm OD tube
Recirculation loop inlet*	10 mm OD tube

Electrical Requirements	
Mains input	230 V ac, 50 Hz 115 V ac, 60 Hz
System control voltage (not including pumps and UV)	24 V dc
Power consumption (peak demand)	650 VA
Electrical protection rating	10 amp

Safety Features
Power fail safe Water temperature alarm* Water purity alarm* Leak detection alarm Access restricted by User Recognition key Low voltage control circuit - 24 V dc Visual alarms Audible alarms

* Output to operate 24 V dc relay.

Product Water Specification			
Flowrate	MEDICA Pro 30	MEDICA Pro 60	MEDICA Pro 120
Daily usage - typical	240	480	960
Daily usage - maximum	720	1440	2880
Inorganic	>10 MΩ. cm @ 25°C		
TOC ppb	<30		
Bacteria	<1 CFU/ml**		
Particles	0.05 µm		

** System to be regularly sanitized and installed following ELGA LabWater installation design guidelines.

As part of our policy of continual improvement we reserve the right to alter the specifications given in this document.

11. WARRANTY/CONDITIONS OF SALE

ELGA LabWater is a trading name of VWS (UK) Ltd.

General Limited Warranty

VWS (UK) Ltd. warrants the products manufactured by it against defects in materials and workmanship when used in accordance with applicable instructions for a period of one year from the date of shipment for the products. VWS (UK) Ltd. MAKES NO OTHER WARRANTY, EXPRESSED OR IMPLIED. THERE IS NO WARRANTY OF MERCHANTABILITY OR FITNESS FOR A PARTICULAR PURPOSE. The warranty provided herein and the data, specifications and descriptions of the VWS (UK) Ltd. products appearing in VWS (UK) Ltd. published catalogues and product literature may not be altered except by express written agreement signed by an officer of VWS (UK) Ltd. Representations, oral or written, which are inconsistent with this warranty or such publications are not authorized and, if given, should not be relied upon.

In the event of a breach of the foregoing warranty, VWS (UK) Ltd. sole obligation shall be to repair or replace, at its option, any product or part thereof that proves to be defective in materials or workmanship within the warranty period, provided the customer notifies VWS (UK) Ltd. promptly of any such defect. The exclusive remedy provided herein shall not be deemed to have failed of its essential purpose so long as VWS (UK) Ltd. is willing and able to repair or replace any nonconforming VWS (UK) Ltd. product or part. VWS (UK) shall not be liable for consequential, incidental, special or any other indirect damages resulting from economic loss or property damage sustained by any customer from the use of its products.

VWS (UK) Ltd. Warranty

VWS (UK) Ltd. warrants the water systems manufactured by it, BUT EXCLUDING MEMBRANES AND PURIFICATION PACKS, against defects in materials and workmanship when used in accordance with the applicable instructions and within the operating conditions specified for the systems for a period of one year from the earlier of:

- a) the date of installation, or
- b) the 120th day following the date of shipment.

VWS (UK) LTD. MAKES NO OTHER WARRANTY, EXPRESSED OR IMPLIED. THERE IS NO WARRANTY OF MERCHANTABILITY OR FITNESS FOR A PARTICULAR PURPOSE. The warranty provided herein and the data, specifications and descriptions of the VWS (UK) Ltd. systems appearing in VWS (UK) Ltd. published catalogues and product literature may not be altered except by express written agreement signed by an officer VWS (UK) Ltd. Representations, oral or written, which are inconsistent with this warranty or such publications are not authorised and, if given, should not be relied upon.

In the event of a breach of the foregoing warranty, VWS (UK) Ltd. sole obligation shall be to repair or replace, at its option, any product or part thereof that proves to be

defective in materials or workmanship within the warranty period, provided the customer notifies VWS (UK) Ltd. promptly of any such defect. The cost of labor for the first ninety (90) days of the above warranty period is included in the warranty; thereafter, labor cost shall be at the customer's expense. The exclusive remedy provided herein shall not be deemed to have failed of its essential purpose so long as VWS (UK) Ltd. is willing and able to repair or replace any nonconforming VWS (UK) Ltd. system or component part. VWS (UK) Ltd. shall not be liable for consequential, incidental, special or any other indirect damages resulting from economic loss or property damage sustained by any customer from the use of its process systems.

Products or components manufactured by companies other than VWS (UK) Ltd. or its affiliates ("Non- VWS (UK) Ltd. products") are covered by the warranty, if any, extended by the Product manufacturer. VWS (UK) Ltd. hereby assigns to the purchaser any such warranty; however VWS (UK) LTD. EXPRESSLY DISCLAIMS ANY WARRANTY WHETHER EXPRESSED OR IMPLIED, THAT THE NON - VWS (UK) Ltd. PRODUCTS ARE MERCHANTABLE OR FIT FOR A PARTICULAR PURPOSE.

NOTICE

VWS (UK) Ltd. is constantly striving to improve its products and services. Consequently, the information in this document is subject to change without notice and should not be construed as a commitment by VWS (UK) Ltd. Also VWS (UK) Ltd. assumes no responsibility for any errors that may appear in this document. This manual is believed to be complete and accurate at the time of publication. In no event shall VWS (UK) Ltd. be liable for incidental or consequential damages in connection with or arising from the use of this manual.

VWS (UK) Ltd. warrants its products against defects in materials and workmanship as described in the Warranty statement on the preceding pages.

12. USEFUL CONTACT DETAILS

ELGA LabWater –Global Operations Centre

Lane End Industrial Park

High Wycombe

Bucks HP14 3BY

UK

Tel: +44 (0) 203 567 7300

Fax: +44 (0) 203 567 7205

E-mail: info@elgalabwater.com

For the address of the nearest ELGA LabWater Sales and Service office visit the country list on our website.

<http://www.elgalabwater.com>

or contact ELGA at the number above.

ELGA® is the global laboratory water brand name of Veolia Water.

ELGA®, PURELAB®, MEDICA® and Centra® are trademarks of ELGA LabWater.

©2007 ELGA LabWater/VWS (UK) Ltd. All rights reserved

Copyright Note

The information contained in this document is the property of VWS (UK) Ltd. and is supplied without liability for errors or omissions.

No part of this document may be reproduced or used except as authorized by contract or other written permission from VWS (UK) Ltd. The copyright and all restrictions on reproduction and use apply to all media in which this information may be placed.

VWS (UK) Ltd. pursue a policy of continual product improvement and reserve the right to alter without notice the specification, design, price or conditions of supply of any product or service.